

ERAH MC Ka

AIR COOLED CHILLERS WITH SCREW COMPRESSORS, AXIAL FANS AND MICROCHANNEL CONDENSING COILS

COOLING CAPACITY FROM 400 to 1580 kW



The images shown above are indicative and not binding.



AIR COOLED CHILLERS EQUIPPED WITH SCREW COMPRESSORS, AXIAL FANS AND MICROCHANNEL CONDENSING COILS

The modular air cooled chillers of ERAH...MC HE Ka are designed for external installation and are particularly suitable for cooling liquid solutions in industrial applications or for air conditioning in commercial field, where excellent seasonal performances must be granted keeping at the same time a low environmental impact, class A efficiency and meeting the seasonal efficiency requirements established by (EU) 2016/2281 Regulation.

Micro channel condensing coils are totally made up of mechanically expanded aluminum alloy. In comparison to the traditional Copper-Aluminum coils, the micro channel geometry provides less resistance to the air passing. This allows to optimize the performances of the fans section and consequently to reduce dimensions keeping performances unchanged.

Moreover the micro channel technology permits to reduce the weight of the condensing section as well as the refrigerant charge.

The cross "V" arrangement of the condensing coils makes the units of this series perfectly each other modular, granting at the same time

the easiest access to the technical room both for checking operations required during the normal unit functioning and for maintenance.

All the units are totally factory assembled and tested, following specific quality procedures. Besides they are totally hydraulic, cooling and electrical connected permitting a quick installation once on site. Before the test the cooling circuits of each unit are subjected to a pressure test and then charged with Refrigerant R134a and non-freezing oil. So, once on site, the units must be only positioned and electrically and hydraulically connected.

Operation limits:

WA application units

Air: from +15 to +38°C ; **water** from 7,1°C to 18°C (outlet from the evaporator)

Unità per applicazione AM

Air: from +15 to +42°C ; **water** from 5°C to 15°C (outlet from the evaporator)

Structure

Structure realized with frame made up of hot galvanized steel sheet and RAL 7035 painted, suitable to resist to atmospheric agents. Compressors and main components are easily accessible and suitably placed in the technical room.

Compressors

Compressors, semi-hermetic type, provided with capacity steps, motor thermal protection, rotation direction control, crankcase heater, discharge side shut-off valve and anti-vibration kit.

Compressors lubrication is of forced type, without pump and to avoid excessive oil migration to the cooling circuits, they are provided with an in-built oil separator. In the standard configuration it is also included a discharge junction flange, as well as steps capacity control system, non-return and safety valve, oil heater, lubrication management system, oil filter, oil service valve, POE oil charge, integral motor protection with protection module, discharge side temperature control device.

The electrical motor of the compressors is provided with an inrush current reduction device obtained thanks to some interlocked contactors. Besides the capacity can be continuously modulated through option M12.

Evaporator

Shell & Tube Evaporator, dry expansion type with pure electrolytic copper tubes and shell and tubes plate made up of carbon steel. The exchanger is provided with anti-condensation insulation made up of a nitrile rubber and polyethylene foam with a thickness of 10 mm externally protected by a UV-ray proof, embossed scratchproof polyethylene film. The hydraulic connections are of Victaulic type. Inside the shell, some plastic and corrosion-proof baffles are suitably placed, allowing a correct water distribution and making the tube bundle particularly strong and vibration free, even with high water flows. Water side exchanger design pressures are 10 bar.

Coils

Micro channel condensing Coils totally made up of mechanically expanded aluminum alloy to grant a perfect and continuous contact among tubes and fins optimizing the thermal exchange and reducing dimensions.

The high passivation degree of the used alloy, besides the peculiar assembling way, avoids the possibility to have galvanic corrosion phenomena. On demand it is also possible to provide the units installed in particularly aggressive environments with surface treatments against exchangers environmental corrosion. (Option ACP and PCP)

Fans

Axial fans, with external rotor directly coupled to a three-phase electronically commutated motor (EC) they have the possibility of a continuous regulation of the speed by means of a 0-10V signal completely managed by the microprocessor. Aluminum blades with wings profile are suitably designed to avoid any turbulence in the air detachment zone, granting in this way the max efficiency with the minimum noise level. The fan is equipped with galvanized steel protection grid pain-

ted after the construction. Thanks to a more accurate adjustment of air flow, they allow operation of the unit with external temperature down to -20 °C.

Refrigerant circuit

Cooling circuit made up of electronic thermostatic expansion valve, sight glass, high pressure safety device, anti-freeze protection on evaporator, high and low pressure switches, non return valve in-built on compressors discharge side, dehydrating filter with replaceable cartridges, shut-off valve on liquid line. Each compressor operates on an independent circuit granting in this way, a considerable reliability.

Electrical board

Electrical board in compliance with CE Norms, contained in a suitable section protected by internal safety panel, provided with a lock-door main switch. Inside all the control and protection components are suitably placed, together with terminal board and auxiliaries. The electrical board also includes the control device for power supply phases to prevent the compressor wrong side rotation. Microprocessor and relevant display are also placed inside the electrical cabinet.

Microprocessor

Electronic Microprocessor for unit management installed inside the electrical cabinet, with double evaporator in/out control of the chilled water temperature, as well as control of working parameters and equalization of compressors working hours, failures auto-detection system, alarm log, start and set point timeslot programming, possibility of remote management and supervision by enabling standard communication protocols management, complete with compressors hour counter.

Applications

Warm applications version (WA)

Units CE certified in compliance with the European regulation 2016/2281 at working conditions, on the use side 23°C / 18°C.

Abroad market version (AM)

Units in compliance with the European regulation whose sales is reserved to countries out of the European Union.

Technical data - ERAH WA MC ka serie

ERAH WA MC KA		4120	4520	5320	6120	7020	7320
Performance data							
Cooling capacity (EN14511)	kW	543,3	609,9	739,4	810,8	935,0	987,0
Total input power (EN14511)	kW	180,2	191,6	219,4	263,3	318,8	334,2
EER	W/W	3,01	3,18	3,37	3,08	2,93	2,95
SEER ⁽¹⁾		4,13	4,13	4,11	4,12	4,11	4,17
η _{s,c} ⁽¹⁾		162,2	162,0	161,5	161,7	161,3	164,0
Refrigerant data R134a							
Global warming potential	GWP	1430	1430	1430	1430	1430	1430
Equivalent CO ₂ charge	t	88,7	94,4	120,1	128,7	137,3	145,9
Refrigerant charge	Kg	62	66	84	90	96	102
Screw compressors							
Quantity/Circuits	n°/n°	2 / 2	2 / 2	2 / 2	2 / 2	2 / 2	2 / 2
Nominal consumption of the unit	A	272,7	286,4	322,4	398,7	496,4	514,9
Max. current consumption of the unit	A	290	360	396	442	566	598
Max. starting current of the unit	A	624	566	702	785	680	714
Axial fans							
Quantity	n°	6	6	8	8	8	10
Motors power input	kW	11,6	14,9	19,8	19,8	19,8	19,4
Total condensing air flow	m ³ /h	127500	162000	216000	216000	216000	212500
Electrical current consumption	A	23,4	30,9	41,2	41,2	41,2	39,0
Shell & Tube Evaporator							
Quantity	n°	1	1	1	1	1	1
Water flow	m ³ /h	93,4	104,9	127,2	139,5	160,8	169,8
Pressure drop	kPa	85,0	69,0	102,0	79,0	61,0	67,0
Sound power level ⁽²⁾	dB(A)	93,3	96,8	97,3	97,6	97,4	97,0
Power supply	V/Hz/Ph	400/50/3	400/50/3	400/50/3	400/50/3	400/50/3	400/50/3

ERAH WA MC KA		8020	9020	10120	10520	11520
Performance data						
Cooling capacity (EN14511)	kW	1083,0	1235,0	1399,0	1468,0	1576,0
Total input power (EN14511)	kW	339,9	387,1	422,5	472,8	486,2
EER	W/W	3,19	3,19	3,31	3,10	3,24
SEER ⁽¹⁾		4,16	4,12	4,11	4,14	4,11
η _{s,c} ⁽¹⁾		163,3	161,7	161,6	162,5	161,2
Refrigerant data R134a						
Global warming potential	GWP	1430	1430	1430	1430	1430
Equivalent CO ₂ charge	t	154,4	185,9	197,3	205,9	237,4
Refrigerant charge	Kg	108	130	138	144	166
Screw compressors						
Quantity/Circuits	n°/n°	2 / 2	2 / 2	2 / 2	2 / 2	2 / 2
Nominal consumption of the unit	A	500,8	583,0	632,0	717,5	733,1
Max. current consumption of the unit	A	630	712	854	948	980
Max. starting current of the unit	A	700	859	981	1166	1172
Axial fans						
Quantity	n°	10	12	14	14	16
Motors power input	kW	24,8	29,8	34,7	34,7	39,7
Total condensing air flow	m ³ /h	270000	324000	378000	378000	432000
Electrical current consumption	A	51,5	61,8	72,1	72,1	82,4
Shell & Tube Evaporator						
Quantity	n°	1	1	1	1	1
Water flow	m ³ /h	186,3	212,4	240,6	252,5	271,1
Pressure drop	kPa	80,0	106,0	114,0	69,0	75,0
Sound power level ⁽²⁾	dB(A)	97,9	98,6	99,1	101,6	101,8
Power supply	V/Hz/Ph	400/50/3	400/50/3	400/50/3	400/50/3	400/50/3

Performances are referred to the following conditions: ambient air temperature 35°C - water 23/18°C

(1) In accordance with (EU) 2016/2281 and relative norms part of this.

(2) Sound power level in accordance with ISO 3744.

Technical data - ERAH AM MC Ka serie

ERAH AM MC Ka		4120	4520	5320	6120	7020	7320
Performance data							
Cooling capacity (EN14511)	kW	401,4	448,9	527,0	610,3	701,0	732,2
Total input power (EN14511)	kW	151,0	167,2	188,0	223,9	275,9	289,4
EER	W/W	2,66	2,68	2,80	2,73	2,54	2,53
SEER ⁽¹⁾		3,27	3,38	3,34	3,34	3,39	3,49
η _{s,c} ⁽¹⁾		127,8	132,3	130,7	130,6	132,5	136,4
Refrigerant data R134a							
Global warming potential	GWP	1430	1430	1430	1430	1430	1430
Equivalent CO ₂ charge	t	88,7	94,4	120,1	128,7	137,3	145,9
Refrigerant charge	Kg	62	66	84	90	96	102
Screw compressors							
Quantity/Circuits	n°/n°	2 / 2	2 / 2	2 / 2	2 / 2	2 / 2	2 / 2
Nominal consumption of the unit	A	223	247	274	329	420	436
Max. current consumption of the unit	A	290	360	396	442	566	598
Max. starting current of the unit	A	602	559	670	754	650	679
Axial fans							
Quantity	n°	6	6	8	8	8	10
Motors power input	kW	11,6	14,9	19,8	19,8	19,8	19,4
Total condensing air flow	m ³ /h	127500	162000	216000	216000	216000	212500
Electrical current consumption	A	23,4	30,9	41,2	41,2	41,2	39,0
Shell & Tube Evaporator							
Quantity	n°	1	1	1	1	1	1
Water flow	m ³ /h	69,2	77,4	90,9	105,2	120,9	126,2
Pressure drop	kPa	53,0	43,0	60,0	51,0	39,0	42,0
Sound power level ⁽²⁾	dB(A)	93,3	96,8	97,3	97,6	97,4	97,0
Power supply	V/Hz/Ph	400/50/3	400/50/3	400/50/3	400/50/3	400/50/3	400/50/3

ERAH AM MC Ka		8020	9020	10120	10520	11520
Performance data						
Cooling capacity (EN14511)	kW	792,2	897,8	1019,0	1049,0	1143,0
Total input power (EN14511)	kW	299,1	329,5	358,7	400,0	413,6
EER	W/W	2,65	2,72	2,84	2,62	2,76
SEER ⁽¹⁾		3,49	3,27	3,32	3,35	3,36
η _{s,c} ⁽¹⁾		136,7	127,7	129,9	130,9	131,2
Refrigerant data R134a						
Global warming potential	GWP	1430	1430	1430	1430	1430
Equivalent CO ₂ charge	t	154,4	185,9	197,3	205,9	237,4
Refrigerant charge	Kg	108	130	138	144	166
Screw compressors						
Quantity/Circuits	n°/n°	2 / 2	2 / 2	2 / 2	2 / 2	2 / 2
Nominal consumption of the unit	A	432	490	528	596	614
Max. current consumption of the unit	A	630	712	854	948	980
Max. starting current of the unit	A	686	837	919	1108	1116
Axial fans						
Quantity	n°	10	12	14	14	16
Motors power input	kW	24,8	29,8	34,7	34,7	39,7
Total condensing air flow	m ³ /h	270000	324000	378000	378000	432000
Electrical current consumption	A	51,5	61,8	72,1	72,1	82,4
Shell & Tube Evaporator						
Quantity	n°	1	1	1	1	1
Water flow	m ³ /h	136,6	154,8	175,7	180,9	197,1
Pressure drop	kPa	49,0	64,0	69,0	41,0	45,0
Sound power level ⁽²⁾	dB(A)	97,9	98,6	99,1	101,6	101,8
Power supply	V/Hz/Ph	400/50/3	400/50/3	400/50/3	400/50/3	400/50/3

Performances are referred to the following conditions: ambient air temperature 35°C - water 12/7°C

(1) In accordance with (EU) 2016/2281 and relative norms part of this.

(2) Sound power level in accordance with ISO 3744.

Technical data - ERAH MC U ka serie

ERAH MC U Ka		4320	5320	6420	8120	10520	11020
Performance data							
Cooling capacity (EN14511)	kW	400,6	523,9	609,6	801,3	997,9	1078,0
Total input power (EN14511)	kW	145,9	184,9	217,1	287,3	349,9	384,4
EER	W/W	2,75	2,83	2,81	2,79	2,85	2,80
SEER ⁽¹⁾		4,11	4,14	4,13	4,15	4,11	4,14
$\eta_{s,c}$ ⁽¹⁾		161,5	162,8	162,2	163,2	161,6	162,7
Refrigerant data R134a							
Global warming potential	GWP	1430	1430	1430	1430	1430	1430
Equivalent CO ₂ charge	t	103,0	128,7	145,9	180,2	237,4	243,1
Refrigerant charge	Kg	72	90	102	126	166	170
Screw compressors							
Quantity/Circuits	n°/n°	2 / 2	2 / 2	2 / 2	2 / 2	2 / 2	2 / 2
Nominal consumption of the unit	A	216	271	320	414	522	573
Max. current consumption of the unit	A	290	396	442	630	854	948
Max. starting current of the unit	A	598	669	752	677	913	1095
Axial fans							
Quantity	n°	8	10	12	14	18	20
Motors power input	kW	6,4	10,0	9,6	14,0	18,0	20,0
Total condensing air flow	m ³ /h	136000	205000	204000	287000	369000	410000
Electrical current consumption	A	8,8	15,0	13,2	21,0	27,0	30,0
Shell & Tube Evaporator							
Quantity	n°	1	1	1	1	1	1
Water flow	m ³ /h	69,1	90,3	105,1	138,2	172,1	185,9
Pressure drop	kPa	21,0	40,0	28,0	27,0	68,0	43,0
Sound power level ⁽²⁾	dB(A)	87,9	91,9	91,4	92,7	93,9	96,1
Power supply	V/Hz/Ph	400/50/3	400/50/3	400/50/3	400/50/3	400/50/3	400/50/3

Performances are referred to the following conditions: ambient air temperature 35°C - water 12/7°C

(1) In accordance with (EU) 2016/2281 and relative norms part of this.

(2) Sound power level in accordance with ISO 3744.

Accessories - ERAH WA MC ka serie

ERAH WA MC Ka		4120	4520	5320	6120	7020	7320
Amperometer	A	o	o	o	o	o	o
Anti-corrosive protection of the condensing coils (AIAX coating)	ACP	o	o	o	o	o	o
Electrical power supply different than standard	AE	o	o	o	o	o	o
Low ambient temperature operation (down to 20°C)	BT	o	o	o	o	o	o
Low ambient temperature operation (down to -20°C)	BF	o	o	o	o	o	o
Soundproofed compressors cabinet with standard material	CF	o	o	o	o	o	o
Compressors inrush counter	CS	o	o	o	o	o	o
Star/Delta	DS	-	-	-	-	o	o
Axial fans with electronic commutated motor	EC	o	o	o	o	o	o
Condensing coil protection grid	GP	o	o	o	o	o	o
Anti-intrusion grid	GP1	o	o	o	o	o	o
RS 485 serial interface	IH	o	o	o	o	o	o
LON Serial interface for LON Protocol	IH (LON)	o	o	o	o	o	o
Seawood packing	IM	o	o	o	o	o	o
Serial interface for SNMP or TCP/IP Protocol	IWG	o	o	o	o	o	o
Modulating capacity control	M12	o	o	o	o	o	o
Buffer tank module	MV	-	-	-	-	-	-
Oil flow safety switch	OS	o	o	o	o	o	o
Pump group	P1	o	o	o	o	o	o
Higher available pressure pump group	P1H	o	o	o	o	o	o
Double pump group (only one working)	P2	o	o	o	o	o	o
Higher available pressure double pump group (only one working)	P2H	o	o	o	o	o	o
Rubber-type vibration dampers	PA	o	o	o	o	o	o
Anti-corrosive protection of the condensing coils (Powder coating)	PCP	o	o	o	o	o	o
Safety water flow switch	PF	o	o	o	o	o	o
Spring-type vibration dampers	PM	o	o	o	o	o	o
Remote display	PQ	o	o	o	o	o	o
In-line twin pump group (only one working)	PT	o	o	o	o	o	o
Anti-freeze heater on evaporator	RA	o	o	o	o	o	o
Power factor correction system cosfi ≥ 0,9	RF	o	o	o	o	o	o
Shut-off valve on suction side	RH	o	o	o	o	o	o
Voltmeter	V	o	o	o	o	o	o
Brine Version	VB	o	o	o	o	o	o
Solenoid valve	VS	o	o	o	o	o	o
Compressors overload relays	RL	o	o	o	o	o	o
Partial heat recovery	RP	o	o	o	o	o	o
Total heat recovery	RT	-	-	-	-	-	-
Electronic thermostatic valve	TE	•	•	•	•	•	•
Part-Winding	PW	•	•	•	•	-	-

• Standard o Optional - Not available

Dimensions - ERAH WA MC ka serie

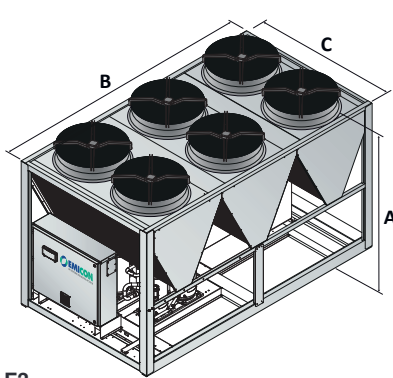

F3

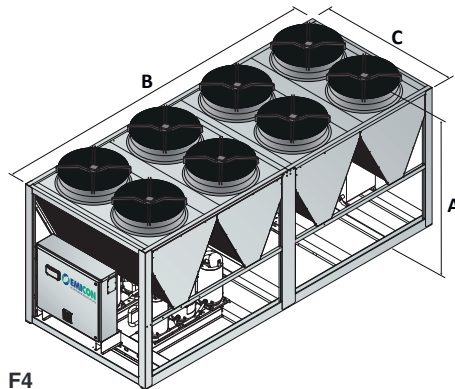

F4

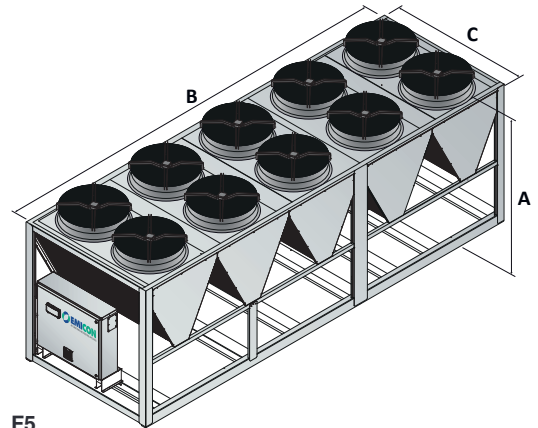

F5

Mod.		A (mm)	B (mm)	C (mm)	Kg
4120	F3	2470	4020	2260	3272
4520	F3	2470	4020	2260	3972
5320	F4	2470	5360	2260	4438
6120	F4	2470	5360	2260	4618
7020	F4	2470	5360	2260	5838
7320	F5	2470	6700	2260	6186

Accessories - ERAH WA MC ka serie

ERAH WA MC Ka		8020	9020	10120	10520	11520
Amperometer	A	o	o	o	o	o
Anti-corrosive protection of the condensing coils (AIAX coating)	ACP	o	o	o	o	o
Electrical power supply different than standard	AE	o	o	o	o	o
Low ambient temperature operation (down to -20°C)	BT	o	o	o	o	o
Low ambient temperature operation (down to -20°C)	BF	o	o	o	o	o
Soundproofed compressors cabinet with standard material	CF	o	o	o	o	o
Compressors inrush counter	CS	o	o	o	o	o
Star/Delta	DS	o	o	o	o	o
Axial fans with electronic commutated motor	EC	o	o	o	o	o
Condensing coil protection grid	GP	o	o	o	o	o
Anti-intrusion grid	GP1	o	o	o	o	o
RS 485 serial interface	IH	o	o	o	o	o
LON Serial interface for LON Protocol	IH (LON)	o	o	o	o	o
Seawood packing	IM	o	o	o	o	o
Serial interface for SNMP or TCP/IP Protocol	IWG	o	o	o	o	o
Modulating capacity control	M12	o	o	o	o	o
Buffer tank module	MV		o	o	o	o
Oil flow safety switch	OS	o	o	o	o	o
Pump group	P1	o	o	o	o	o
Higher available pressure pump group	P1H	o	o	o	o	o
Double pump group (only one working)	P2	o	o	o	o	o
Higher available pressure double pump group (only one working)	P2H	o	o	o	o	o
Rubber-type vibration dampers	PA	o	o	o	o	o
Anti-corrosive protection of the condensing coils (Powder coating)	PCP	o	o	o	o	o
Safety water flow switch	PF	o	o	o	o	o
Spring-type vibration dampers	PM	o	o	o	o	o
Remote display	PQ	o	o	o	o	o
In-line twin pump group (only one working)	PT	o	o	o	o	o
Anti-freeze heater on evaporator	RA	o	o	o	o	o
Power factor correction system cosfi ≥ 0,9	RF	o	o	o	o	o
Shut-off valve on suction side	RH	o	o	o	o	o
Voltmeter	V	o	o	o	o	o
Brine Version	VB	o	o	o	o	o
Solenoid valve	VS	o	o	o	o	o
Compressors overload relays	RL	o	o	o	o	o
Partial heat recovery	RP	o	o	o	o	o
Total heat recovery	RT	-	-	-	-	-
Electronic thermostatic valve	TE	●	●	●	●	●
Part-Winding	PW	o	o	o	o	o

● Standard o Optional - Not available

Dimensions - ERAH WA MC ka serie

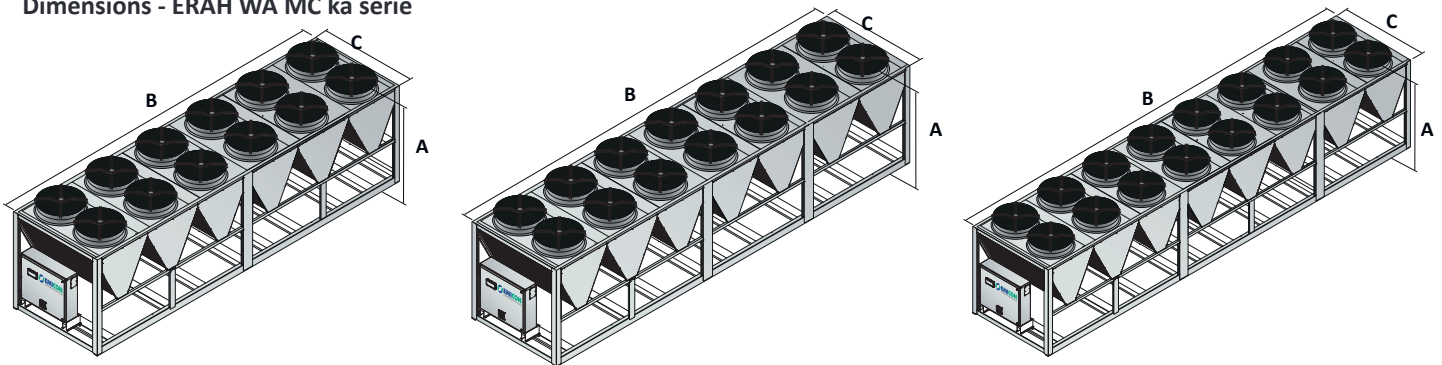

F6

F7

F8

Mod.		A (mm)	B (mm)	C (mm)	Kg
8020	F5	2470	6700	2260	6242
9020	F6	2470	8040	2260	6654
10120	F7	2470	9380	2260	7312
10520	F7	2470	9380	2260	7340
11520	F8	2470	10720	2260	7756

Accessories - ERAH AM MC Ka serie

ERAH AM MC Ka		4120	4520	5320	6120	7020	7320
Amperometer	A	o	o	o	o	o	o
Anti-corrosive protection of the condensing coils (AIAX coating)	ACP	o	o	o	o	o	o
Electrical power supply different than standard	AE	o	o	o	o	o	o
Low ambient temperature operation (down to -20°C)	BT	o	o	o	o	o	o
Low ambient temperature operation (down to -20°C)	BF	o	o	o	o	o	o
Soundproofed compressors cabinet with standard material	CF	o	o	o	o	o	o
Compressors inrush counter	CS	o	o	o	o	o	o
Star/Delta	DS	-	-	-	-	o	o
Axial fans with electronic commutated motor	EC	o	o	o	o	o	o
Condensing coil protection grid	GP	o	o	o	o	o	o
Anti-intrusion grid	GP1	o	o	o	o	o	o
RS 485 serial interface	IH	o	o	o	o	o	o
LON Serial interface for LON Protocol	IH (LON)	o	o	o	o	o	o
Seawood packing	IM	o	o	o	o	o	o
Serial interface for SNMP or TCP/IP Protocol	IWG	o	o	o	o	o	o
Modulating capacity control	M12	o	o	o	o	o	o
Buffer tank module	MV	-	-	-	-	-	-
Oil flow safety switch	OS	o	o	o	o	o	o
Pump group	P1	o	o	o	o	o	o
Higher available pressure pump group	P1H	o	o	o	o	o	o
Double pump group (only one working)	P2	o	o	o	o	o	o
Higher available pressure double pump group (only one working)	P2H	o	o	o	o	o	o
Rubber-type vibration dampers	PA	o	o	o	o	o	o
Anti-corrosive protection of the condensing coils (Powder coating)	PCP	o	o	o	o	o	o
Safety water flow switch	PF	o	o	o	o	o	o
Spring-type vibration dampers	PM	o	o	o	o	o	o
Remote display	PQ	o	o	o	o	o	o
In-line twin pump group (only one working)	PT	o	o	o	o	o	o
Anti-freeze heater on evaporator	RA	o	o	o	o	o	o
Power factor correction system cosφ ≥ 0,9	RF	o	o	o	o	o	o
Shut-off valve on suction side	RH	o	o	o	o	o	o
Voltmeter	V	o	o	o	o	o	o
Brine Version	VB	o	o	o	o	o	o
Solenoid valve	VS	o	o	o	o	o	o
Compressors overload relays	RL	o	o	o	o	o	o
Partial heat recovery	RP	o	o	o	o	o	o
Total heat recovery	RT	-	-	-	-	-	-
Electronic thermostatic valve	TE	•	•	•	•	•	•
Part-Winding	PW	•	•	•	•	-	-

• Standard o Optional - Not available

Dimensions - ERAH AM MC Ka serie

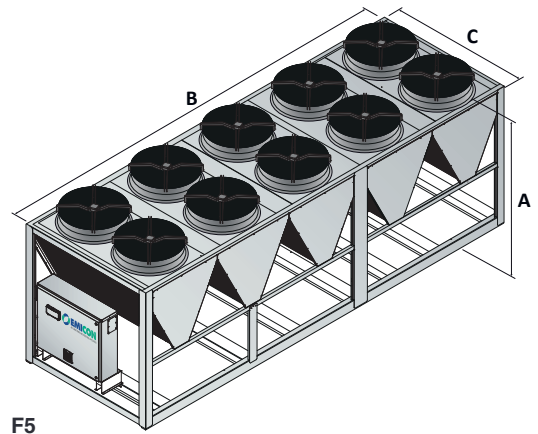
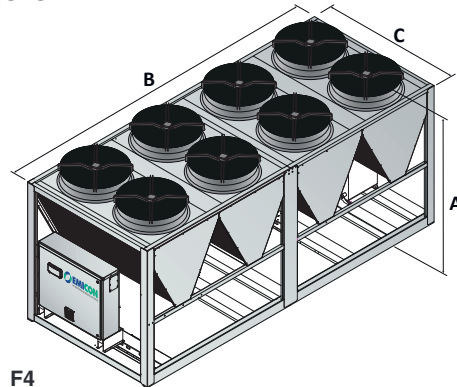
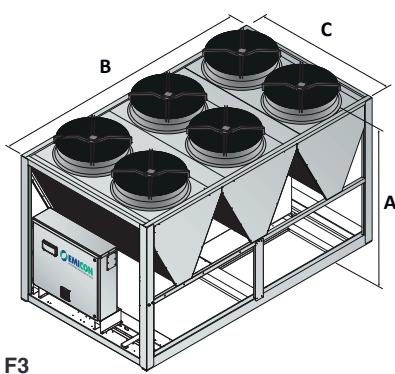

Mod.		A (mm)	B (mm)	C (mm)	Kg
4120	F3	2470	4020	2260	3272
4520	F3	2470	4020	2260	3972
5320	F4	2470	5360	2260	4438
6120	F4	2470	5360	2260	4618
7020	F4	2470	5360	2260	5838
7320	F5	2470	6700	2260	6186

Accessories - ERAH AM MC Ka serie

ERAH AM MC Ka		8020	9020	10120	10520	11520
Amperometer	A	o	o	o	o	o
Anti-corrosive protection of the condensing coils (AIAX coating)	ACP	o	o	o	o	o
Electrical power supply different than standard	AE	o	o	o	o	o
Low ambient temperature operation (down to -20°C)	BT	o	o	o	o	o
Low ambient temperature operation (down to -20°C)	BF	o	o	o	o	o
Soundproofed compressors cabinet with standard material	CF	o	o	o	o	o
Compressors inrush counter	CS	o	o	o	o	o
Star/Delta	DS	o	o	o	o	o
Axial fans with electronic commutated motor	EC	o	o	o	o	o
Condensing coil protection grid	GP	o	o	o	o	o
Anti-intrusion grid	GP1	o	o	o	o	o
RS 485 serial interface	IH	o	o	o	o	o
LON Serial interface for LON Protocol	IH (LON)	o	o	o	o	o
Seawood packing	IM	o	o	o	o	o
Serial interface for SNMP or TCP/IP Protocol	IWG	o	o	o	o	o
Modulating capacity control	M12	o	o	o	o	o
Buffer tank module	MV		o	o	o	o
Oil flow safety switch	OS	o	o	o	o	o
Pump group	P1	o	o	o	o	o
Higher available pressure pump group	P1H	o	o	o	o	o
Double pump group (only one working)	P2	o	o	o	o	o
Higher available pressure double pump group (only one working)	P2H	o	o	o	o	o
Rubber-type vibration dampers	PA	o	o	o	o	o
Anti-corrosive protection of the condensing coils (Powder coating)	PCP	o	o	o	o	o
Safety water flow switch	PF	o	o	o	o	o
Spring-type vibration dampers	PM	o	o	o	o	o
Remote display	PQ	o	o	o	o	o
In-line twin pump group (only one working)	PT	o	o	o	o	o
Anti-freeze heater on evaporator	RA	o	o	o	o	o
Power factor correction system cosfi ≥ 0,9	RF	o	o	o	o	o
Shut-off valve on suction side	RH	o	o	o	o	o
Voltmeter	V	o	o	o	o	o
Brine Version	VB	o	o	o	o	o
Solenoid valve	VS	o	o	o	o	o
Compressors overload relays	RL	o	o	o	o	o
Partial heat recovery	RP	o	o	o	o	o
Total heat recovery	RT	-	-	-	-	-
Electronic thermostatic valve	TE	●	●	●	●	●
Part-Winding	PW	o	o	o	o	o

● Standard o Optional - Not available

Dimensions - ERAH AM MC Ka serie

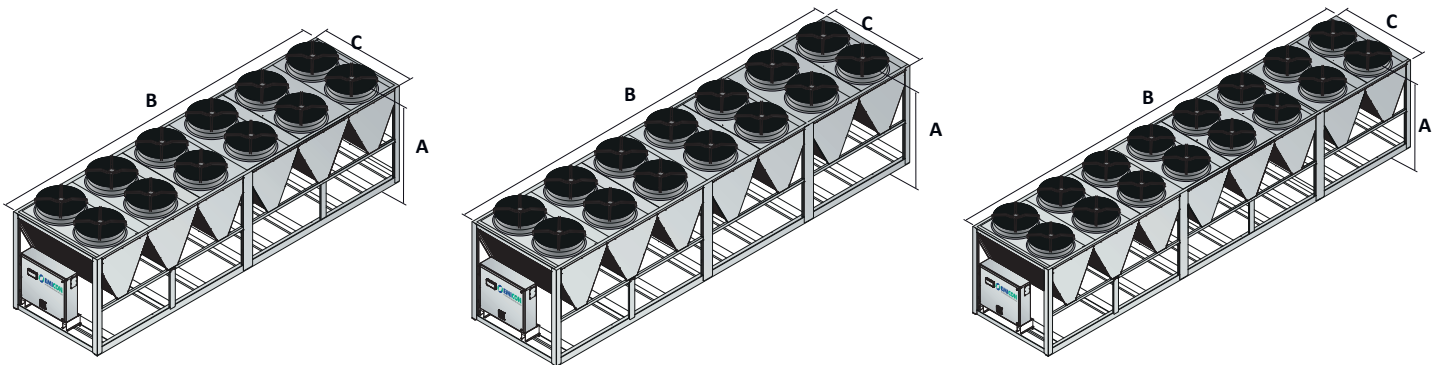

F6

F7

F8

Mod.		A (mm)	B (mm)	C (mm)	Kg
8020	F5	2470	6700	2260	6242
9020	F6	2470	8040	2260	6654
10120	F7	2470	9380	2260	7312
10520	F7	2470	9380	2260	7340
11520	F8	2470	10720	2260	7756

AIR COOLED CHILLERS

Accessories - ERAH MC U Ka serie

ERAH MC U Ka		4320	5320	6420	8120	10520	11020
Amperometer	A	o	o	o	o	o	o
Anti-corrosive protection of the condensing coils (AIAX coating)	ACP	o	o	o	o	o	o
Electrical power supply different than standard	AE	o	o	o	o	o	o
Soundproofed compressors cabinet with standard material	CF	●	●	●	●	●	●
Compressors inrush counter	CS	o	o	o	o	o	o
Star/Delta	DS	-	-	-	o	o	o
Axial fans with electronic commutated motor	EC	●	●	●	●	●	●
Condensing coil protection grid	GP	o	o	o	o	o	o
Anti-intrusion grid	GP1	o	o	o	o	o	o
RS 485 serial interface	IH	o	o	o	o	o	o
LON Serial interface for LON Protocol	IH (LON)	o	o	o	o	o	o
Seawood packing	IM	o	o	o	o	o	-
Serial interface for SNMP or TCP/IP Protocol	IWG	o	o	o	o	o	o
Modulating capacity control	M12	-	o	o	o	o	o
Buffer tank module	MV	o	o	o	o	o	o
Oil flow safety switch	OS	o	o	o	o	o	o
Pump group	P1	o	o	o	o	o	o
Higher available pressure pump group	P1H	o	o	o	o	o	o
Double pump group (only one working)	P2	o	o	o	o	o	o
Higher available pressure double pump group (only one working)	P2H	o	o	o	o	o	o
Rubber-type vibration dampers	PA	o	o	o	o	o	o
Anti-corrosive protection of the condensing coils (Powder coating)	PCP	o	o	o	o	o	o
Safety water flow switch	PF	o	o	o	o	o	o
Spring-type vibration dampers	PM	o	o	o	o	o	o
Remote display	PQ	o	o	o	o	o	o
In-line twin pump group (only one working)	PT	o	o	o	o	o	o
Anti-freeze heater on evaporator	RA	o	o	o	o	o	o
Power factor correction system cosφ ≥ 0,9	RF	o	o	o	o	o	o
Shut-off valve on suction side	RH	o	o	o	o	o	o
Voltmeter	V	o	o	o	o	o	o
Brine Version	VB	o	o	o	o	o	o
Solenoid valve	VS	o	o	o	o	o	o
Compressors overload relays	RL	o	o	o	o	o	o
Partial heat recovery	RP	o	o	o	o	o	o
Total heat recovery	RT	o	o	o	o	o	o
Electronic thermostatic valve	TE	●	●	●	●	●	●
Part-Winding	PW	●	●	●	-	-	-

● Standard o Optional - Not available

Dimensions - ERAH MC U Ka serie

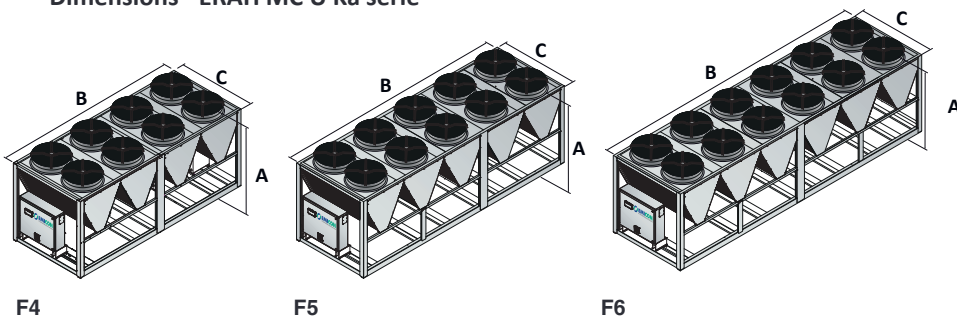

F4

F5

F6

Mod.		A (mm)	B (mm)	C (mm)	Kg
4320	F4	2470	5360	2260	3880
5320	F5	2470	6700	2260	5124
6420	F6	2470	8040	2260	5538
8120	F7	2470	9380	2260	7234
10520	F9	2470	12060	2260	8282
11020	F10	2470	13400	2260	8586

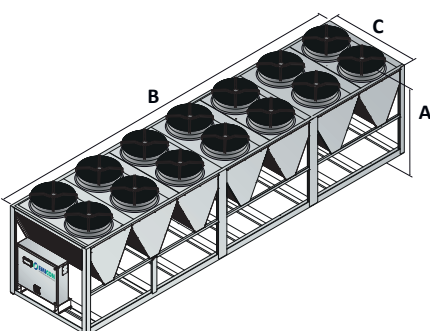

F7

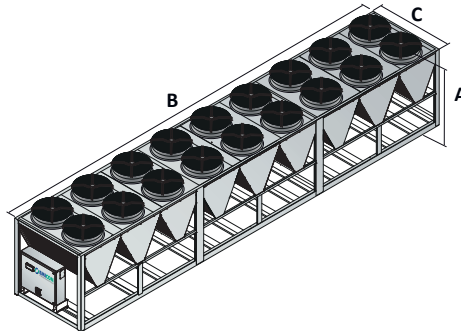

F9

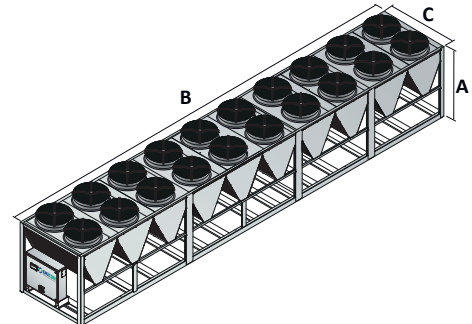

F

ERAH MC HE Ka

AIR COOLED CHILLERS WITH SCREW COMPRESSORS, AXIAL FANS AND MICROCHANNEL CONDENSING COILS

COOLING CAPACITY FROM 490 to 1240 kW



The images shown above are indicative and not binding.



AIR COOLED CHILLERS EQUIPPED WITH SCREW COMPRESSORS, AXIAL FANS AND MICROCHANNEL CONDENSING COILS

The modular air cooled chillers of ERAH...MC HE Ka are designed for external installation and are particularly suitable for cooling liquid solutions in industrial applications or for air conditioning in commercial field, where excellent seasonal performances must be granted keeping at the same time a low environmental impact, class A efficiency and meeting the seasonal efficiency requirements established by (EU) 2016/2281 Regulation.

Micro channel condensing coils are totally made up of mechanically expanded aluminum alloy. In comparison to the traditional Copper-Aluminum coils, the micro channel geometry provides less resistance to the air passing. This allows to optimize the performances of the fans section and consequently to reduce dimensions keeping performances unchanged.

Moreover the micro channel technology permits to reduce the weight of the condensing section as well as the refrigerant charge.

The cross "V" arrangement of the condensing coils makes the units of this series perfectly each other modular, granting at the same time the easiest access to the technical room both for checking operations required during the normal unit functioning and for maintenance.

All the units are totally factory assembled and tested, following specific quality procedures. Besides they are totally hydraulic, cooling and electrical connected permitting a quick installation once on site. Before the test the cooling circuits of each unit are subjected to a pressure test and then charged with Refrigerant R134a and non-freezing oil. So, once on site, the units must be only positioned and electrically and hydraulically connected.

Operation limits:

Standard unit

Air: from -20°C to +45°C ; **water** from 5°C to 15°C (outlet from the evaporator).

Structure

Structure realized with frame made up of hot galvanized steel sheet and RAL 7035 painted, suitable to resist to atmospheric agents. Compressors and main components are easily accessible and suitably placed in the technical room.

Compressors

Compressors, semi-hermetic type, provided with capacity steps, motor thermal protection, rotation direction control, crankcase heater, discharge side shut-off valve and anti-vibration kit.

Compressors lubrication is of forced type, without pump and to avoid excessive oil migration to the cooling circuits, they are provided with an in-built oil separator. In the standard configuration it is also included a discharge junction flange, as well as steps capacity control system, non-return and safety valve, oil heater, lubrication management system, oil filter, oil service valve, POE oil charge, integral motor protection with protection module, discharge side temperature control device.

The electrical motor of the compressors is provided with an inrush current reduction device obtained thanks to some interlocked contactors. Besides the capacity can be continuously modulated through option M12.

Evaporator

Shell & Tube Evaporator, dry expansion type with pure electrolytic copper tubes and shell and tubes plate made up of carbon steel. The exchanger is provided with anti-condensation insulation made up of a nitrile rubber and polyethylene foam with a thickness of 10 mm externally protected by a UV-ray proof, embossed scratchproof polyethylene film. The hydraulic connections are of Victaulic type. Inside the shell, some plastic and corrosion-proof baffles are suitably placed, allowing a correct water distribution and making the tube bundle particularly strong and vibration free, even with high water flows. Water side exchanger design pressures are 10 bar.

Coils

Micro channel condensing Coils totally made up of mechanically expanded aluminum alloy to grant a perfect and continuous contact among tubes and fins optimizing the thermal exchange and reducing dimensions.

The high passivation degree of the used alloy, besides the peculiar assembling way, avoids the possibility to have galvanic corrosion phenomena. On demand it is also possible to provide the units installed in particularly aggressive environments with surface treatments against exchangers environmental corrosion. (Option ACP and PCP)

Fans

Axial fans, with external rotor directly coupled to a three-phase electronically commutated motor (EC) they have the possibility of a continuous regulation of the speed by means of a 0-10V signal completely managed by the microprocessor. Aluminum blades with wings profile are suitably designed to avoid any turbulence in the air detachment zone, granting in this way the max efficiency with the minimum noise level. The fan is equipped with galvanized steel protection grid painted after the construction. Thanks to a more accurate adjustment of air flow, they allow operation of the unit with external temperature down to -20 °C.

Refrigerant circuit

Cooling circuit made up of electronic thermostatic expansion valve, sight glass, high pressure safety device, anti-freeze protection on evaporator, high and low pressure switches, non return valve in-built on compressors discharge side, dehydrating filter with replaceable cartridges, shut-off valve on liquid line. Each compressor operates on an independent circuit granting in this way, a considerable reliability.

Electrical board

Electrical board in compliance with CE Norms, contained in a suitable section protected by internal safety panel, provided with a lock-door main switch. Inside all the control and protection components are suitably placed, together with terminal board and auxiliaries. The electrical board also includes the control device for power supply phases to prevent the compressor wrong side rotation. Microprocessor and relevant display are also placed inside the electrical cabinet.

Microprocessor

Electronic Microprocessor for unit management installed inside the electrical cabinet, with double evaporator in/out control of the chilled water temperature, as well as control of working parameters and equalization of compressors working hours, failures auto-detection system, alarm log, start and set point timeslot programming, possibility of remote management and supervision by enabling standard communication protocols management, complete with compressors hour counter.

Versions

High efficiency version (HE)

Units with full load efficiency Eurovent class A EER ≥ 3.1.

Technical data - ERAH MC HE ka serie

ERAH MC HE Ka		482	522	562	612	672	732	792
Performance data								
Cooling capacity (EN14511)	kW	487,8	514,8	557,1	613,1	657,9	717,6	793,8
Total input power (EN14511)	kW	157,0	164,7	179,2	197,2	208,6	230,9	254,9
EER	W/W	3,11	3,13	3,11	3,11	3,15	3,11	3,11
SEER ⁽¹⁾		4,12	4,13	4,11	4,10	4,12	4,12	4,13
η _{s,c} ⁽¹⁾		162,0	162,3	161,3	161,1	161,6	161,6	162,1
Refrigerant data R134a								
Global warming potential	GWP	1430	1430	1430	1430	1430	1430	1430
Equivalent CO ₂ charge	t	120,1	123,0	134,4	143,0	151,6	161,6	178,8
Refrigerant charge	Kg	84	86	94	100	106	113	125
Screw compressors								
Quantity/Circuits	n°/n°	2 / 2	2 / 2	2 / 2	2 / 2	2 / 2	2 / 2	2 / 2
Nominal consumption of the unit	A	235	245	266	291	305	345	387
Max. current consumption of the unit	A	360	378	396	419	442	504	566
Max. starting current of the unit	A	553	646	666	727	744	746	634
Axial fans								
Quantity	n°	8	10	10	10	12	12	12
Motors power input	kW	12,0	15,0	15,0	15,0	18,0	18,0	18,0
Total condensing air flow	m ³ /h	200000	250000	250000	250000	300000	300000	300000
Electrical current consumption	A	18,4	23,0	23,0	23,0	27,6	27,6	27,6
Shell & Tube Evaporator								
Quantity	n°	1	1	1	1	1	1	1
Water flow	m ³ /h	84,1	88,8	96,1	105,7	113,4	123,7	136,9
Pressure drop	kPa	28,0	33,0	42,0	28,0	32,0	20,0	23,0
Sound power level ⁽²⁾	dB(A)	96,6	96,8	97,0	97,1	97,4	97,4	97,4
Power supply	V/Hz/Ph	400/50/3	400/50/3	400/50/3	400/50/3	400/50/3	400/50/3	400/50/3

ERAH MC HE Ka		872	982	1002	1102	1202	1302
Performance data							
Cooling capacity (EN14511)	kW	868,2	977,6	1028,5	1098,2	1167,6	1239,1
Total input power (EN14511)	kW	280,0	314,3	330,4	351,5	375,2	397,3
EER	W/W	3,10	3,11	3,11	98,9	3,11	3,12
SEER ⁽¹⁾		4,12	4,14	4,12	4,14	4,11	4,11
η _{s,c} ⁽¹⁾		162,0	162,4	162,0	162,7	161,4	161,2
Refrigerant data R134a							
Global warming potential	GWP	1430	1430	1430	1430	1430	1430
Equivalent CO ₂ charge	t	205,9	234,5	234,5	243,1	268,8	268,8
Refrigerant charge	Kg	144	164	164	170	188	188
Screw compressors							
Quantity/Circuits	n°/n°	2 / 2	2 / 2	2 / 2	2 / 2	2 / 2	2 / 2
Nominal consumption of the unit	A	405	476	501	515	563	596
Max. current consumption of the unit	A	630	712	783	854	948	980
Max. starting current of the unit	A	673	828	894	912	1091	1107
Axial fans							
Quantity	n°	14	16	16	18	20	20
Motors power input	kW	21,0	24,0	24,0	27,0	30,0	30,0
Total condensing air flow	m ³ /h	350000	400000	400000	450000	500000	500000
Electrical current consumption	A	32,2	36,8	36,8	41,4	46,0	46,0
Shell & Tube Evaporator							
Quantity	n°	1	1	1	1	1	1
Water flow	m ³ /h	149,7	168,6	177,3	189,3	201,3	213,6
Pressure drop	kPa	49,0	34,0	37,0	42,0	43,0	47,0
Sound power level ⁽²⁾	dB(A)	97,6	98,3	98,5	98,8	101,4	101,6
Power supply	V/Hz/Ph	400/50/3	400/50/3	400/50/3	400/50/3	400/50/3	400/50/3

Performances are referred to the following conditions: ambient air temperature 35°C - water 12/7°C

(1) In accordance with (EU) 2016/2281 and relative norms part of this.

(2) Sound power level in accordance with ISO 3744.

Accessories - ERAH MC HE ka serie

ERAH MC HE Ka		482	522	562	612	672	732	792
Amperometer	A	o	o	o	o	o	o	o
Anti-corrosive protection of the condensing coils (AIAX coating)	ACP	o	o	o	o	o	o	o
Electrical power supply different than standard	AE	o	o	o	o	o	o	o
Soundproofed compressors cabinet with standard material	CF	o	o	o	o	o	o	o
Compressors inrush counter	CS	o	o	o	o	o	o	o
Star/Delta	DS	-	-	-	-	-	o	o
Condensing coil protection grid	GP	o	o	o	o	o	o	o
Anti-intrusion grid	GP1	o	o	o	o	o	o	o
RS 485 serial interface	IH	o	o	o	o	o	o	o
LON Serial interface for LON Protocol	IH (LON)	o	o	o	o	o	o	o
Seawood packing	IM	o	o	o	o	o	o	o
Serial interface for SNMP or TCP/IP Protocol	IWG	o	o	o	o	o	o	o
Modulating capacity control	M12	o	o	o	o	o	o	o
Buffer tank module	MV	-	-	-	-	o	o	o
Oil flow safety switch	OS	o	o	o	o	o	o	o
Pump group	P1	o	o	o	o	o	o	o
Higher available pressure pump group	P1H	o	o	o	o	o	o	o
Double pump group (only one working)	P2	o	o	o	o	o	o	o
Higher available pressure double pump group (only one working)	P2H	o	o	o	o	o	o	o
Rubber-type vibration dampers	PA	o	o	o	o	o	o	o
Anti-corrosive protection of the condensing coils (Powder coating)	PCP	o	o	o	o	o	o	o
Safety water flow switch	PF	o	o	o	o	o	o	o
Spring-type vibration dampers	PM	o	o	o	o	o	o	o
Remote display	PQ	o	o	o	o	o	o	o
In-line twin pump group (only one working)	PT	o	o	o	o	o	o	o
Anti-freeze heater on evaporator	RA	o	o	o	o	o	o	o
Power factor correction system cosfi ≥ 0,9	RF	o	o	o	o	o	o	o
Shut-off valve on suction side	RH	o	o	o	o	o	o	o
Voltmeter	V	o	o	o	o	o	o	o
Brine Version	VB	o	o	o	o	o	o	o
Solenoid valve	VS	o	o	o	o	o	o	o
Compressors overload relays	RL	o	o	o	o	o	o	o
Partial heat recovery	RP	o	o	o	o	o	o	o
Total heat recovery	RT	-	-	-	-	-	-	-
Axial fans with electronic commutated motor	EC	•	•	•	•	•	•	•
Electronic thermostatic valve	TE	•	•	•	•	•	•	•
	PW	•	•	•	•	•	-	-

• Standard o Optional - Not available

Dimensions - ERAH MC HE ka serie

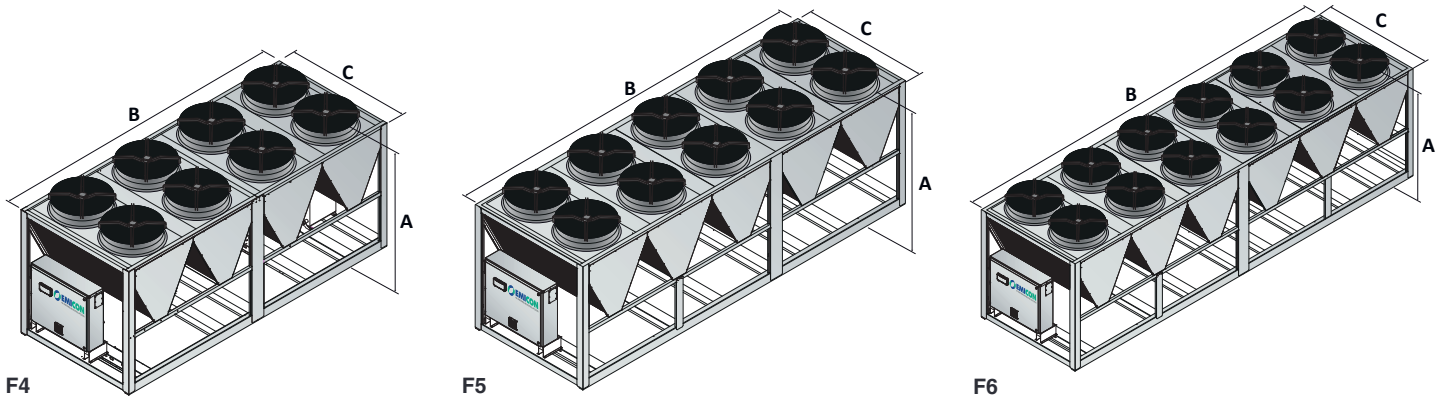

Mod.		A (mm)	B (mm)	C (mm)	Kg
482	F4	2470	5360	2260	4258
522	F5	2470	6700	2260	4656
562	F5	2470	6700	2260	4826
612	F5	2470	6700	2260	4846
672	F6	2470	8040	2260	5240
732	F6	2470	8040	2260	5866
792	F6	2470	8040	2260	6488

Accessories - ERAH MC HE ka serie

ERAH MC HE Ka		872	982	1002	1102	1202	1302
Amperometer	A	o	o	o	o	o	o
Anti-corrosive protection of the condensing coils (AIAX coating)	ACP	o	o	o	o	o	o
Electrical power supply different than standard	AE	o	o	o	o	o	o
Soundproofed compressors cabinet with standard material	CF	o	o	o	o	o	o
Compressors inrush counter	CS	o	o	o	o	o	o
Star/Delta	DS	o	o	o	o	o	o
Condensing coil protection grid	GP	o	o	o	o	o	o
Anti-intrusion grid	GP1	o	o	o	o	o	o
RS 485 serial interface	IH	o	o	o	o	o	o
LON Serial interface for LON Protocol	IH (LON)	o	o	o	o	o	o
Seawood packing	IM	o	o	o	o	-	-
Serial interface for SNMP or TCP/IP Protocol	IWG	o	o	o	o	o	o
Modulating capacity control	M12	o	o	o	o	o	o
Buffer tank module	MV	o	o	o	o	o	o
Oil flow safety switch	OS	o	o	o	o	o	o
Pump group	P1	o	o	o	o	o	o
Higher available pressure pump group	P1H	o	o	o	o	o	o
Double pump group (only one working)	P2	o	o	o	o	o	o
Higher available pressure double pump group (only one working)	P2H	o	o	o	o	o	o
Rubber-type vibration dampers	PA	o	o	o	o	o	o
Anti-corrosive protection of the condensing coils (Powder coating)	PCP	o	o	o	o	o	o
Safety water flow switch	PF	o	o	o	o	o	o
Spring-type vibration dampers	PM	o	o	o	o	o	o
Remote display	PQ	o	o	o	o	o	o
In-line twin pump group (only one working)	PT	o	o	o	o	o	o
Anti-freeze heater on evaporator	RA	o	o	o	o	o	o
Power factor correction system cosfi ≥ 0,9	RF	o	o	o	o	o	o
Shut-off valve on suction side	RH	o	o	o	o	o	o
Voltmeter	V	o	o	o	o	o	o
Brine Version	VB	o	o	o	o	o	o
Solenoid valve	VS	o	o	o	o	o	o
Compressors overload relays	RL	o	o	o	o	o	o
Partial heat recovery	RP	o	o	o	o	o	o
Total heat recovery	RT	o	o	o	o	o	o
Axial fans with electronic commutated motor	EC	●	●	●	●	●	●
Electronic thermostatic valve	TE	●	●	o	o	o	o
Part-Winding	PW	o	o	o	o	o	o

● Standard o Optional - Not available

Dimensions - ERAH MC HE ka serie

Mod.		A (mm)	B (mm)	C (mm)	Kg
872	F7	2470	9380	2260	7136
982	F8	2470	10720	2260	7574
1002	F8	2470	10720	2260	7588
1102	F9	2470	12060	2260	7998
1202	F10	2470	13400	2260	8310
1302	F10	2470	13400	2260	8316

ERAH MC VS HE Ka

AIR COOLED CHILLERS WITH SCREW COMPRESSORS, AXIAL FANS AND MICROCHANNEL CONDENSING COILS

COOLING CAPACITY FROM 500 to 1110 kW



The images shown above are indicative and not binding.



AIR COOLED CHILLERS EQUIPPED WITH SCREW COMPRESSORS, AXIAL FANS AND MICROCHANNEL CONDENSING COILS

The modular air cooled chillers of ERAH...MC VS HE Ka are designed for external installation and are particularly suitable for cooling liquid solutions in industrial applications or for air conditioning in commercial field, where excellent seasonal performances must be granted keeping at the same time a low environmental impact, class A efficiency and meeting the seasonal efficiency requirements established by (EU) 2016/2281 Regulation.

The units are provided with two semi-hermetic screw compressors, one of which is inverter driven for a continuous and modulating control of the cooling capacity. Each compressor works on a single circuit, completely independent, assuring in this way the maximum reliability.

Micro channel condensing coils are totally made up of aluminum alloy. In comparison to the traditional Copper-Aluminum coils, the micro channel geometry provides less resistance to the air passing, at the same heat exchange capacity. This allows to optimize the performances of the fans section and consequently to reduce dimensions

keeping performances and electrical absorption unchanged.

Moreover, the micro channel technology allows a significant reduction in weight of the condensing section as well as the refrigerant charge.

The cross "V" arrangement of the condensing coils makes the units of this series perfectly each other modular, granting at the same time the easiest access to the technical room both for checking operations required during the normal unit functioning and for maintenance.

All the units are totally factory assembled and tested, following specific quality procedures. Besides they are totally hydraulic, cooling and electrical connected permitting a quick installation once on site. Before the test the cooling circuits of each unit are subjected to a pressure test and then charged with Refrigerant R134a and non-freezing oil. So, once on site, the units must be only positioned and electrically and hydraulically connected.

Operation Limits:

Standard unit

Air: from -20°C to +45°C; **water** from 5°C to 15°C (outlet from the evaporator).

Structure

Structure realized with frame made up of hot galvanized steel sheet and RAL 7035 painted, suitable to resist to atmospheric agents. Compressors and main components are easily accessible and suitably placed in the technical room.

Compressors

Compressors semi-hermetic type, one of which frequency inverter driven, allowing the adjustment of the capacity to the cooling charge, assuring the best efficiency at the different working conditions. The compressors are provided with motor thermal protection, rotation direction control, crankcase heater, oil filter and service valve, POE oil charge, discharge side shut-off valve and anti-vibration kit. Compressors lubrication is of forced type, without pump and to avoid excessive oil migration to the cooling circuits, they are provided with an in-built oil separator on the discharge side. The electrical motor of the compressors is provided with an automatic partial load inrush system and some interlocked inrush contactors so to avoid accidental short circuits (standard for sizes from 482 MC VS HE Ka to 672 MC VS HE Ka, option DS for the other sizes).

Evaporator

Shell & Tube Evaporator, dry expansion type with pure electrolytic copper tubes and shell and tubes plate made up of carbon steel. The exchanger is provided with anti-condensation insulation made up of a nitrile rubber and polyethylene foam with a thickness of 10 mm externally protected by a UV-ray proof, embossed scratchproof polyethylene film. The hydraulic connections are of Victaulic type. Inside the shell, some plastic and corrosion-proof baffles are suitably placed, allowing a correct water distribution and making the tube bundle particularly strong and vibration free, even with high water flows. Water side exchanger design pressures are 10 bar.

Coils

Micro channel condensing Coils totally made up of mechanically expanded aluminum alloy to grant a perfect and continuous contact among tubes and fins optimizing the thermal exchange and reducing dimensions.

The high passivation degree of the used alloy, besides the peculiar assembling way, avoids the possibility to have galvanic corrosion phenomena. On demand it is also possible to provide the units installed in particularly aggressive environments with surface treatments against exchangers environmental corrosion. (Option ACP and PCP).

Fans

Axial fans, with external rotor directly coupled to a three-phase electronically commutated motor (EC) they have the possibility of a continuous regulation of the speed by means of a 0-10V signal completely managed by the microprocessor. Aluminum blades with wings profile are suitably designed to avoid any turbulence in the air detachment zone, granting in this way the max efficiency with the minimum noise level. The fan is equipped with galvanized steel protection grid painted after the construction. Thanks to a more accurate adjustment of air flow, they allow operation of the unit with external temperature down to -20 °C.

Refrigerant circuit

Cooling circuit made up of electronic thermostatic expansion valve,

sight glass, high pressure safety device, anti-freeze protection on evaporator, high and low pressure switches, non return valve in-built on compressors discharge side, dehydrating filter with replaceable cartridges, shut-off valve on liquid line. Each compressor operates on an independent circuit granting in this way, a considerable reliability.

Electrical board

Electrical board in compliance with CE Norms, contained in a suitable section protected by internal safety panel, provided with a lock-door main switch. Inside all the control and protection components are suitably placed, together with terminal board and auxiliaries. The electrical board also includes the control device for power supply phases to prevent the compressor wrong side rotation. Microprocessor and relevant display are also placed inside the electrical cabinet.

Microprocessor

Electronic Microprocessor for unit management installed inside the electrical cabinet, with double evaporator in/out control of the chilled water temperature, as well as control of working parameters and equalization of compressors working hours, failures auto-detection system, alarm log, start and set point timeslot programming, possibility of remote management and supervision by enabling standard communication protocols management, complete with compressors hour counter.

Versions

High efficiency version (HE)

Units with full load efficiency Eurovent class A EER ≥ 3.1.

Technical data - ERAH MC VS HE Ka serie

ERAH MC VS HE Ka		482	522	562	612	672	732
Performance data							
Cooling capacity (EN14511)	kW	502,6	529,9	573,3	627,0	682,7	738,7
Total input power (EN14511)	kW	161,1	168,4	184,0	201,6	213,8	236,0
EER	W/W	3,12	3,15	3,12	3,11	3,19	3,13
SEER ⁽¹⁾		4,15	4,21	4,15	4,16	4,18	4,21
η _{s,c} ⁽¹⁾		163,1	165,6	162,9	163,3	164,1	165,2
Refrigerant data R134a							
Global warming potential	GWP	1430	1430	1430	1430	1430	1430
Equivalent CO ₂ charge	t	120,1	123,0	134,4	143,0	151,6	161,6
Refrigerant charge	Kg	84	86	94	100	106	113
Screw compressors							
Quantity/Circuits	n°/n°	2 / 2	2 / 2	2 / 2	2 / 2	2 / 2	2 / 2
Nominal consumption of the unit	A	250	263	293	300	326	367
Max. current consumption of the unit	A	415	433	480	503	553	615
Max. starting current of the unit	A	565	658	687	727	757	609
Axial fans							
Quantity	n°	8	10	10	10	12	12
Motors power input	kW	12,0	15,0	15,0	15,0	18,0	18,0
Total condensing air flow	m ³ /h	200000	250000	250000	250000	300000	300000
Electrical current consumption	A	18,4	23,0	23,0	23,0	27,6	27,6
Shell & Tube Evaporator							
Quantity	n°	1	1	1	1	1	1
Water flow	m ³ /h	86,7	91,4	98,8	108,1	117,7	127,4
Pressure drop	kPa	29,0	34,0	44,0	29,0	33,0	21,0
Sound power level ⁽²⁾	dB(A)	96,6	96,8	97,0	97,1	97,4	97,4
Power supply	V/Hz/Ph	400/50/3	400/50/3	400/50/3	400/50/3	400/50/3	400/50/3

ERAH MC VS HE Ka		792	872	982	1002	1102
Performance data						
Cooling capacity (EN14511)	kW	813,0	893,4	1001,2	1052,7	1110,6
Total input power (EN14511)	kW	261,1	286,5	321,4	337,8	351,4
EER	W/W	3,11	3,12	3,12	3,12	3,16
SEER ⁽¹⁾		4,16	4,16	4,17	4,14	4,15
η _{s,c} ⁽¹⁾		163,4	163,6	163,7	162,5	163,1
Refrigerant data R134a						
Global warming potential	GWP	1430	1430	1430	1430	1430
Equivalent CO ₂ charge	t	178,8	205,9	234,5	234,5	243,1
Refrigerant charge	Kg	125	144	164	164	170
Screw compressors						
Quantity/Circuits	n°/n°	2 / 2	2 / 2	2 / 2	2 / 2	2 / 2
Nominal consumption of the unit	A	412	438	504	529	544
Max. current consumption of the unit	A	658	742	811	882	901
Max. starting current of the unit	A	650	696	848	914	932
Axial fans						
Quantity	n°	12	14	16	16	18
Motors power input	kW	18,0	21,0	24,0	24,0	27,0
Total condensing air flow	m ³ /h	300000	350000	400000	400000	450000
Electrical current consumption	A	27,6	32,2	36,8	36,8	41,4
Shell & Tube Evaporator						
Quantity	n°	1	1	1	1	1
Water flow	m ³ /h	140,2	154,0	172,6	181,5	191,5
Pressure drop	kPa	23,0	50,0	35,0	37,0	42,0
Sound power level ⁽²⁾	dB(A)	97,4	97,6	98,3	98,5	98,8
Power supply	V/Hz/Ph	400/50/3	400/50/3	400/50/3	400/50/3	400/50/3

Performances are referred to the following conditions: ambient air temperature 35°C - water 12/7°C

(1) In accordance with (EU) 2016/2281 and relative norms part of this.

(2) Sound power level in accordance with ISO 3744.

Accessories - ERAH MC VS HE Ka serie

ERAH MC VS HE Ka		482	522	562	612	672	732
Amperometer	A	o	o	o	o	o	o
Anti-corrosive protection of the condensing coils (AIAX coating)	ACP	o	o	o	o	o	o
Electrical power supply different than standard	AE	o	o	o	o	o	o
Soundproofed compressors cabinet with standard material	CF	-	-	-	-	-	-
Compressors inrush counter	CS	o	o	o	o	o	o
Star/Delta	DS	-	-	-	-	-	o
Condensing coil protection grid	GP	o	o	o	o	o	o
Anti-intrusion grid	GP1	o	o	o	o	o	o
RS 485 serial interface	IH	o	o	o	o	o	o
LON Serial interface for LON Protocol	IH (LON)	o	o	o	o	o	o
Seawood packing	IM	o	o	o	o	o	o
Serial interface for SNMP or TCP/IP Protocol	IWG	o	o	o	o	o	o
Buffer tank module	MV	-	-	-	-	o	o
Oil flow safety switch	OS	o	o	o	o	o	o
Pump group	P1	o	o	o	o	o	o
Higher available pressure pump group	P1H	o	o	o	o	o	o
Double pump group (only one working)	P2	o	o	o	o	o	o
Higher available pressure double pump group (only one working)	P2H	o	o	o	o	o	o
Rubber-type vibration dampers	PA	o	o	o	o	o	o
Anti-corrosive protection of the condensing coils (Powder coating)	PCP	o	o	o	o	o	o
Safety water flow switch	PF	o	o	o	o	o	o
Spring-type vibration dampers	PM	o	o	o	o	o	o
Remote display	PQ	o	o	o	o	o	o
In-line twin pump group (only one working)	PT	o	o	o	o	o	o
Anti-freeze heater on evaporator	RA	o	o	o	o	o	o
Power factor correction system cosfi ≥ 0,9	RF	o	o	o	o	o	o
Shut-off valve on suction side	RH	o	o	o	o	o	o
Voltmeter	V	o	o	o	o	o	o
Brine Version	VB	o	o	o	o	o	o
Solenoid valve	VS	o	o	o	o	o	o
Compressors overload relays	RL	o	o	o	o	o	o
Partial heat recovery	RP	o	o	o	o	o	o
Total heat recovery	RT	-	-	-	-	-	-
Electronic thermostatic valve	TE	●	●	●	●	●	●
Part-Winding	PW	●	●	●	●	●	-
Axial fans with electronic commutated motor	EC	●	●	●	●	●	●

● Standard o Optional - Not available

Dimensions - ERAH MC VS HE Ka serie

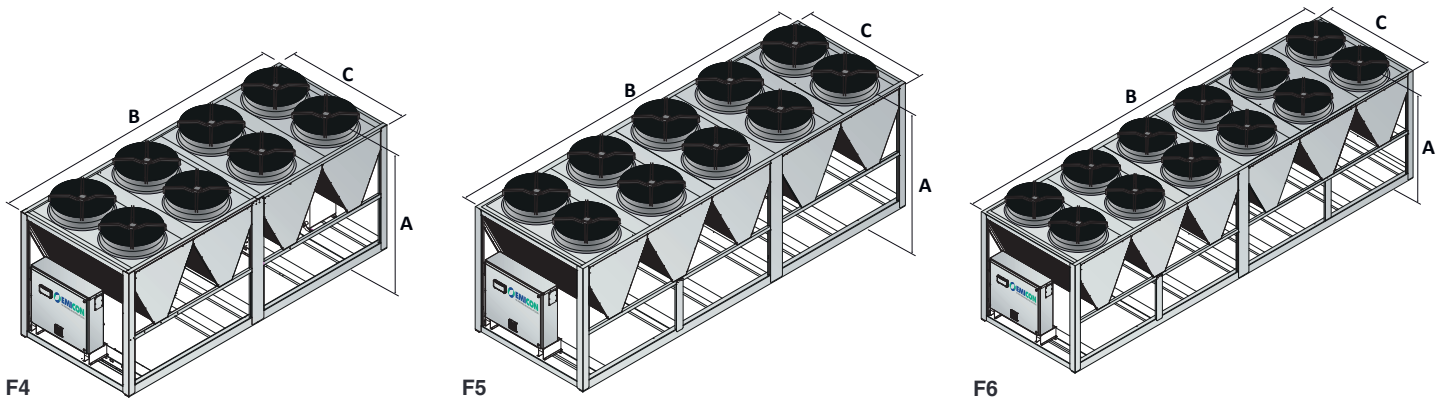

Mod.		A (mm)	B (mm)	C (mm)	Kg
482	F4	2470	5360	2260	4338
522	F5	2470	6700	2260	4736
562	F5	2470	6700	2260	4900
612	F5	2470	6700	2260	4918
672	F6	2470	8040	2260	5918
732	F6	2470	8040	2260	5946

Accessories - ERAH MC VS HE Ka serie

ERAH MC VS HE Ka		792	872	982	1002	1102
Amperometer	A	o	o	o	o	o
Anti-corrosive protection of the condensing coils (AIAX coating)	ACP	o	o	o	o	o
Electrical power supply different than standard	AE	o	o	o	o	o
Soundproofed compressors cabinet with standard material	CF	-	-	-	-	-
Compressors inrush counter	CS	o	o	o	o	o
Star/Delta	DS	o	o	o	o	o
Condensing coil protection grid	GP	o	o	o	o	o
Anti-intrusion grid	GP1	o	o	o	o	o
RS 485 serial interface	IH	o	o	o	o	o
LON Serial interface for LON Protocol	IH (LON)	o	o	o	o	o
Seawood packing	IM	o	o	o	o	o
Serial interface for SNMP or TCP/IP Protocol	IWG	o	o	o	o	o
Buffer tank module	MV	o	o	o	o	o
Oil flow safety switch	OS	o	o	o	o	o
Pump group	P1	o	o	o	o	o
Higher available pressure pump group	P1H	o	o	o	o	o
Double pump group (only one working)	P2	o	o	o	o	o
Higher available pressure double pump group (only one working)	P2H	o	o	o	o	o
Rubber-type vibration dampers	PA	o	o	o	o	o
Anti-corrosive protection of the condensing coils (Powder coating)	PCP	o	o	o	o	o
Safety water flow switch	PF	o	o	o	o	o
Spring-type vibration dampers	PM	o	o	o	o	o
Remote display	PQ	o	o	o	o	o
In-line twin pump group (only one working)	PT	o	o	o	o	o
Anti-freeze heater on evaporator	RA	o	o	o	o	o
Power factor correction system cosφ ≥ 0,9	RF	o	o	o	o	o
Shut-off valve on suction side	RH	o	o	o	o	o
Voltmeter	V	o	o	o	o	o
Brine Version	VB	o	o	o	o	o
Solenoid valve	VS	o	o	o	o	o
Compressors overload relays	RL	o	o	o	o	o
Partial heat recovery	RP	o	o	o	o	o
Total heat recovery	RT	-	-	-	-	-
Electronic thermostatic valve	TE	●	●	●	●	●
Part-Winding	PW	-	-	-	-	-
Axial fans with electronic commutated motor	EC	●	●	●	●	●

● Standard o Optional - Not available

Dimensions - ERAH MC VS HE Ka serie

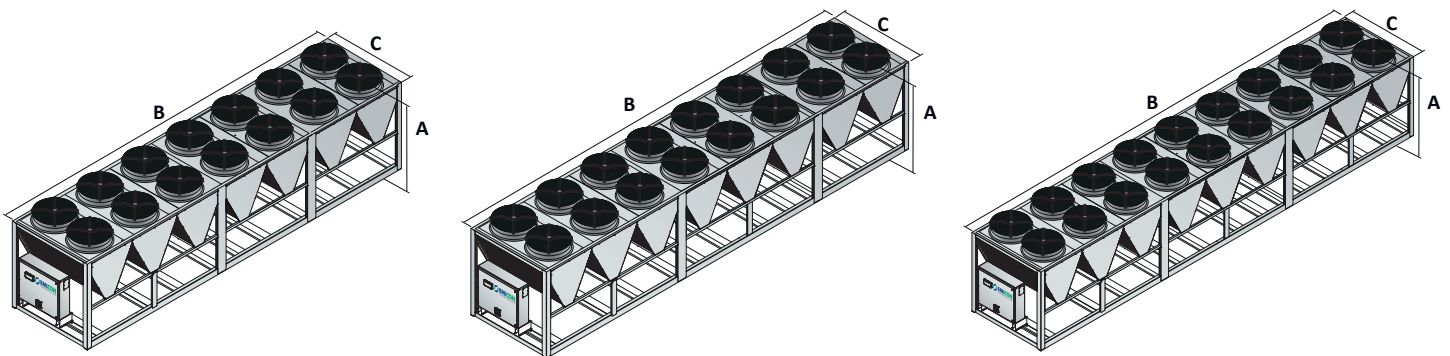

F7

F8

F9

Mod.		A (mm)	B (mm)	C (mm)	Kg
792	F6	2470	8040	2260	6582
872	F7	2470	9380	2260	7232
982	F8	2470	10720	2260	7668
1002	F8	2470	10720	2260	7668
1102	F9	2470	12060	2260	8078